

TPS20 Series

Features

- DC4-20mA analog signal (2-wire) transmission by measuring pressure of liquid, gas, and oil.
- High accuracy ($\pm 0.3\%$ F.S.) with stainless steel diaphragm for various measurement
- Various model for installation environments
: Head type, DIN connector type, connector cable type
- Built-in zero-point, span adjustment (head type)



Please read "Safety Considerations" in operation manual before using this unit.

CE



[Head type] [DIN connector type] [Connector cable type]

Ordering Information

TPS20 – G 1 5 F8 (0 to 5kgf/cm²)

① ② ③ ④ ⑤ ⑥

		Description	
① Item	TPS20	Pressure Transmitter	
② Measurement pressure	G	Gauge pressure	
	A	Absolute pressure	
③ Cable	1	Head type	
	2	DIN connector type	
	3	Connector cable type	
④ Pressure range		Gauge pressure	Absolute pressure
	1	0 to 0.2kgf/cm ²	—
	2	0 to 0.5kgf/cm ²	—
	3	0 to 1kgf/cm ²	0 to 1kgf/cm ²
	4	0 to 2kgf/cm ²	0 to 2kgf/cm ²
	5	0 to 7kgf/cm ²	0 to 7kgf/cm ²
	6	0 to 10kgf/cm ²	0 to 10kgf/cm ²
	7	0 to 20kgf/cm ²	0 to 20kgf/cm ²
	8	0 to 35kgf/cm ²	0 to 35kgf/cm ²
	9	0 to 70kgf/cm ²	—
	A	0 to 100kgf/cm ²	—
	C	0 to 200kgf/cm ²	—
	F	0 to 300kgf/cm ²	—
	H	0 to 350kgf/cm ²	—
	M	-760mmHg to 0kgf/cm ²	—
	O	-760mmHg to 1kgf/cm ²	—
	Q	-760mmHg to 7kgf/cm ²	—
	V	-760mmHg to 10kgf/cm ²	—
	X	-760mmHg to 20kgf/cm ²	—
	Y	-760mmHg to 35kgf/cm ²	—
Z	Others		
⑤ Pressure port	P2	R1/2 (with adapter, PT)	
	P8	R3/8 (with adapter, PT)	
	F8	G3/8 (standard, PF)	
	ZZ	Others	
⑥ User pressure range		User pressure range*1	

*1: Write the desired pressure range and it is the default of user pressure range. (select "Z" at ④Pressure range)

* For ordering cable, order as CID3-2, CID3-5, CLD3-2, CLD3-5. (sold separately)

Pressure Transmitter

Dimensions

• Head type

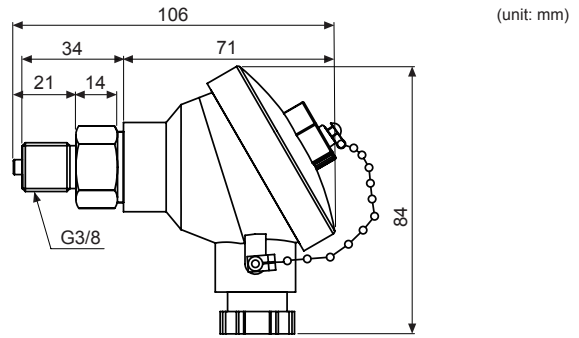
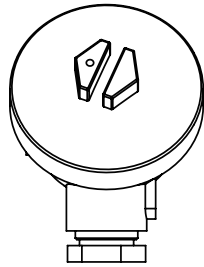
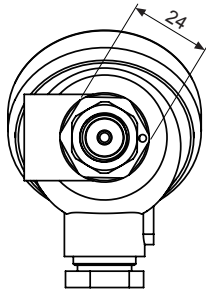

• DIN connector type

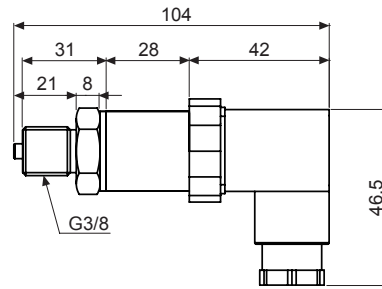
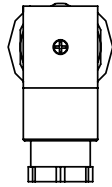
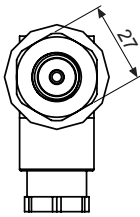

• Connector cable type

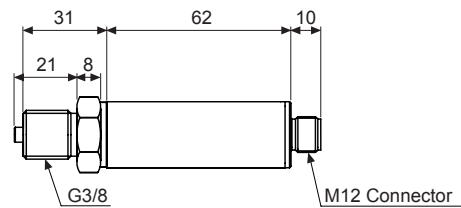
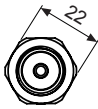

※The standard pressure port for above is G3/8.

Connection Cable (Sold Separately)

• CID3-2 / CID3-5

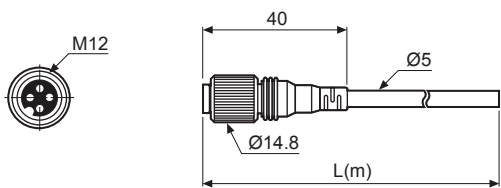

Model	L (m)	Material
CID3-2	2	PVC
CID3-5	5	

• CLD3-2 / CLD3-5

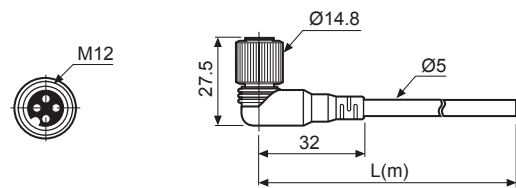

Model	L (m)	Material
CLD3-2	2	PVC
CLD3-5	5	

Connections

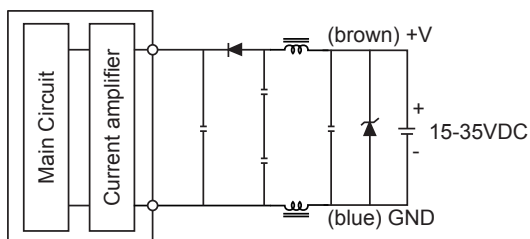

A. Recorders

B. Indicators

C. Converters

D. Controllers

E. Thyristor Power Controllers

F. Pressure Transmitters

G. Temperature Transmitters

H. Accessories

TPS30

TPS20

KT-302H

PTF30

TPS20 Series

Connector

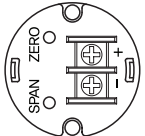
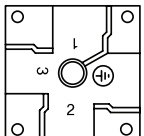
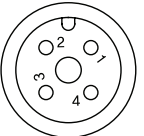
Head type		DIN connector type			Connector cable type		
	Pin		Pin	Function		Pin	Function
	+						
-	2	-	2	-	2	N-C	
			3	N-C	3	F.G.	
			⊕	F.G.	4	-	

※In case of head type, remove the top cover.



• Example of external connections

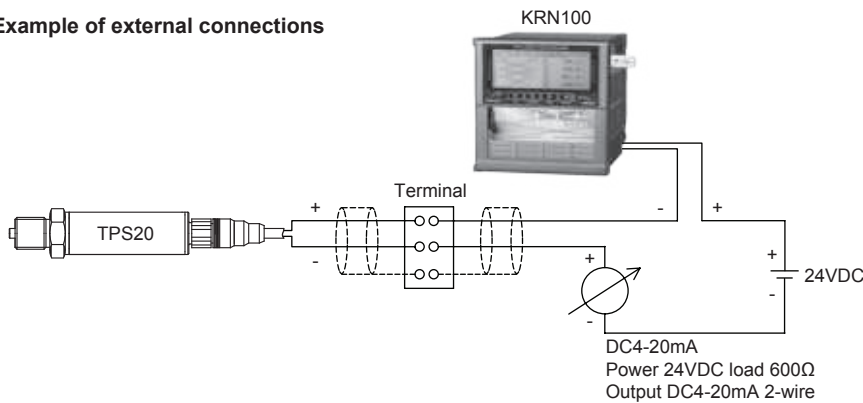

Specifications

Series	TPS20		
Pressure type	Gauge pressure	Absolute pressure	Compound pressure
Rated pressure range	0 to 0.2 to 350kgf/cm ²	0 to 1.0 to 35kgf/cm ²	-760mmHg to 0 to 30kgf/cm ²
Max. pressure range	300% of max. span		
Measured materials	Liquid, gas, oil (except corrosive environment of stainless steel type 316)		
Power supply	15-35VDC=		
Permissible voltage range	90 to 110% of rated voltage		
Current consumption	Max. 50mA		
Response time	Max. 100ms		
Protection circuit	Reverse polarity protection circuit		
Current output	DC4-20mA		
Linearity	±0.3% F.S. (-10 to 50°C), ±0.5% F.S. (50 to 70°C)		
Hysteresis	±0.3% F.S.		
Temp. Zero Shift	±0.03% F.S.		
Temp. Span Shift	±0.03% F.S. (at 25°C)		
Load resistance	Max. 600Ω		
Insulation resistance	Over 100MΩ (at 500VDC megger)		
Dielectric strength	500VAC 50/60Hz for 1 minute		
Vibration	1.5mm amplitude at frequency of 10 to 55Hz (for 1 min) in each X, Y, Z direction for 2 hours		
Shock	95m/s ²		
Tightening torque	Industrial plug over 5N		
Pressure port	G3/8t (standard), R3/8, R1/2		
Environment	Ambient temp.	-10 to 70°C, storage: -10 to 70°C	
	Ambient humi.	5 to 95% RH, storage: 5 to 95% RH	
Materials	Sealing, diaphragm, connection: stainless steel type 316, O-ring: fluoro rubber		
Connection	+, -		
Case structure	Drip-proof structure		
Approval	CE		
Weight ^{※1}	Approx. 350g (approx. 320g) (based on head type)		

※ 1: The weight includes packaging. The weight in parenthesis is for unit only.

※ F.S.(Full Scale): It is rated pressure range.

※ Environment resistance is rated at no freezing or condensation.

Pressure Transmitter

Troubleshooting

Error	Troubleshooting
No outputs	Check the power supply. Check the polarity (+, -) when wiring cable. Check the connection part.
Abnormally fluctuating output	Check the power supply. Check the supplied pressure. Check the pressure line.
Out of zero point output value	Check the power supply. Check the load resistive value of current output type for a receiver is over 600Ω. Check the measuring point and transmission distance. Check the line resistance is below 600Ω.

Proper Usage

- When installing the unit on pipe line, use the hexagon part of connections not to turn the unit with a pipe wrench. Do not use the unit with strong vibrations.
 - This unit is manufactured with precisely. If you drop or shock the unit, it may lose the function. Please treat the unit carefully.
 - Store the unit at the place without moisture, dust, and vibration.
 - This product which does not have drive part at sensing part does not need to repair it. Even though inside of pressure pipe is normally clean, it needs to take maintenance once a year as below instructions.
 - ① Check the broken status of outside.
 - ② Check the pressure slot, cleanliness inside, and corrosion state.
 - ③ Short each terminal and check the insulation resistance between the case and power. (at 100VDC, over 10MΩ)
 - ④ Check zero, span adjustment and linearity by pressure standards.
 - When removing a sensor for maintenance, follow the below instructions.
 - ① Replace an O-ring which is used once.
 - ② Be sure that diaphragm part is not damaged.
 - In case of head type for connecting the power, use a crimp terminal. (M3.5, max. 7.2mm)
 - The connection of this unit should be separated from the power line and high voltage line in order to prevent inductive noise.
 - Install a power switch or a circuit breaker to supply or cut off the power.
 - Connect the power with the crimp terminals.
 - Switch or circuit breaker should be installed nearby users for convenient control.
 - Do not use the unit near the high frequency instruments (high frequency welding machine & sewing machine, large capacity SCR controller).
 - The unit cannot be repaired due to disassembled structure.
 - The unit is fixed with bolt and nut at the both sides of case. Do not press excessive load (approx. 300kg/cm²), or it may cause damage to the unit.
 - Do not pull the cables with over 30N of tension force.
 - Tighten the cable connection part firmly not to enter water to the cable.
 - This product may be used in the following environments.
 - ① Indoor / Outdoor
 - ② Altitude max. 2,000m
 - ③ Pollution degree 2
 - ④ Installation category II
- ※We are not responsible for any damages and claims for careless. Must read the proper usage.

A. Recorders

B. Indicators

C. Converters

D. Controllers

E. Thyristor Power Controllers

F. Pressure Transmitters

G. Temperature Transmitters

H. Accessories

TPS30

TPS20

KT-302H

PTF30